

Piezo Switch N.O.



PSE M22 with cable PUR

PSE M30

See below:

Approvals and Compliances

Description

- Designed for IP67 applications
- Tight housing, potted PUR-Cable
- Switch with Ring Illumination
- PUR-Cable with 15m length
- RGB: flexible input voltage 5 - 28 VDC at constant brightness
- 7 possible colors with RGB configuration

Unique Selling Proposition

- Designed for IP67 applications
- Waterproof from the front surface to the connection point
- High quality PUR cable 15m
- RGB illumination and variable input voltage

Characteristics

- Housing material: stainless steel 1.4462, ring illumination made of polyamide
- For use in harsh environments, both indoors and outdoors (see technical data)

Other versions on request

- Switch for longer switching signal duration, type: PSE IV
- Switch for explosion proof applications, type: PSE EX
- Switch with enhanced vandal proof protection, type: PSE HI

References

- Alternative: switch vandal improved: [PSE HI 22](#)
- Alternative: switch for EX-proof applications:
- Alternative: Other diameter
- Alternative: switch with prolonged signal: [PSE AE 16](#); [PSE AE 30](#); [PSE IV 19](#)

Weblinks

- [pdf data sheet](#), [html datasheet](#), [General Product Information](#), [CAD-Drawings](#), [Product News](#), [Detailed request for product](#)

Technical Data

Electrical Data

Switching Function	momentary
Supply Voltage RGB	5 - 28 VDC
Switching Voltage	max. 42 / 60 VAC/DC
Switching current	max. 100 mA
Electrical Rating	1 W
Lifetime	20 million actuations at Rated Switching Capacity
Switch Resistance OFF	> 10 MΩ
Switch Resistance ON	< 20 Ω actuated (Ta = 25°C)
Capacity	5 nF
N.O. Closing Impulse Duration	20- 1000 ms depending on actuating force, time and speed
Contact Configuration	free polarity

RGB Illumination

Current Consumption (max per color)	16.5 mA @ 5 VDC
	8.2 mA @ 12 VDC
	5.5 mA @ 24 VDC
	4.8 mA @ 28 VDC

Mechanical Data

Actuating Force	≤ 3 N at ambient temperature
Actuating Travel	0.002 mm
Shock Protection	IK02
Mounting screw torque	2.5 Nm

Climatical Data

Operating Temperature	-40 to 85 °C
Storage Temperature	-40 to 85 °C
IP-Protection	IP67 acc. to IEC 60529, IP69K acc. to DIN 40050-9

Environmental Assessment	+55°C / 93% r.h. acc. to DIN EN 60068-2-30
Salt Spray Test (acc. to DIN 50021-SS)	24 h / 48 h / 96 h Residence Time

Material

Housing (depending on type)	Stainless Steel 1.4462
Actuating Area / Insert (with Ring Illumination)	Stainless Steel 1.4462
Illuminated Ring (Ring Illumination)	Polyamide





Approvals and Compliances

Detailed information on product approvals, code requirements, usage instructions and detailed test conditions can be looked up in [Details about Approvals](#)

SCHURTER products are designed for use in industrial environments. They have approvals from independent testing bodies according to national and international standards. Products with specific characteristics and requirements such as required in the automotive sector according to IATF 16949, medical technology according to ISO 13485 or in the aerospace industry can be offered exclusively with customer-specific, individual agreements by SCHURTER.





Application standards

Application standards where the product can be used

Organization	Design	Standard	Description
	Suitable for applications acc.	EMC Directive:	EMC directive 2014/30/EU
	Suitable for applications acc.	MIL-STD:	202F Method 107G, 202F Method 204D, 202F Method 213B, 416D Method RS103, 810E Method 501.3, 810E Method 502.3, 810E Method 507.3
	Suitable for applications acc.	VDE Certificate Number:	DIN EN 61000-4-2, DIN EN 61000-4-4, DIN EN 61000-4-5
	Suitable for applications acc.	IEC/UL 62368-1	Audio/video, information and communication technology equipment - Part 1: Safety requirements

Compliances

The product complies with following Guide Lines

Identification	Details	Initiator	Description
	CE declaration of conformity	SCHURTER AG	The CE marking declares that the product complies with the applicable requirements laid down in the harmonisation of Community legislation on its affixing in accordance with EU Regulation 765/2008.
	UKCA declaration of conformity	SCHURTER AG	The UKCA marking declares that the product complies with the applicable requirements laid down in the British Amendment of Regulation (EC) 765/2008.
	RoHS	SCHURTER AG	Directive RoHS 2011/65/EU, Amendment (EU) 2015/863
	REACH	SCHURTER AG	On 1 June 2007, Regulation (EC) No 1907/2006 on the Registration, Evaluation, Authorization and Restriction of Chemicals 1 (abbreviated as "REACH") entered into force.

Dimension [mm]

PSE M22

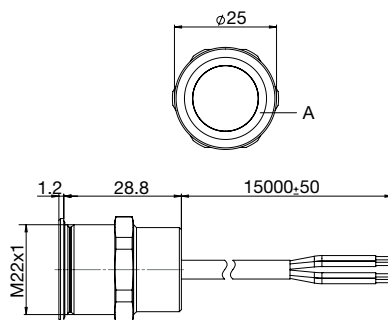

PSE M30

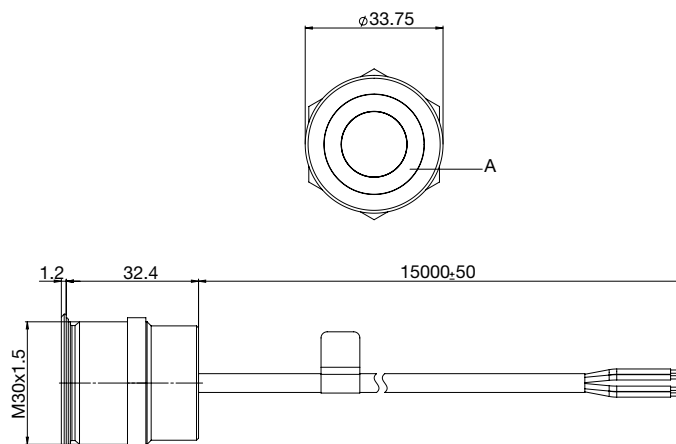

Design actuating area

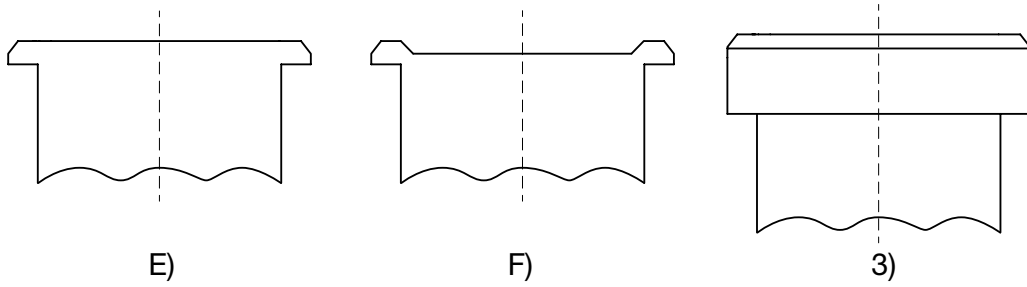

Legend:
 A = Illumination Area
 B = Width Across Flats
 E) without finger guidance
 F) with finger guidance (on request)
 3) elevated front design: M19 (standard and others on request)

Dimension

PSE 22 RGB

PSE M30 RGB

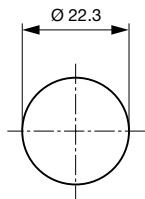

Drilling diagram

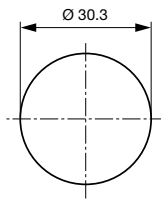

Drilling diagram

Diagrams

PSE with cable

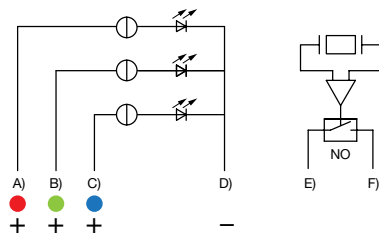

- A) Pink cable - red LED
- B) Green cable - green LED
- C) Yellow cable - blue LED
- D) Cable 4 brown
- E) Cable 5/6 white
- F) Cable 5/6 grey

Illumination options for RGB

Lighting type	Active terminal A) ●	Active terminal B) ●	Active terminal C) ●	Resulting Color
Multicolor Singlecolor	A			Red ●
Multicolor Singlecolor		B		Green ●
Multicolor Singlecolor			C	Blue ●
Multicolor RGB Additive 2	A	B		Yellow ●
Multicolor RGB Additive 2	A		C	Magenta ●
Multicolor RGB Additive 2		B	C	Cyan ●
Multicolor RGB Additive 3	A	B	C	White ○

Cable specification

Cable rolled up to a diameter of ca. 200mm. Ends 100-200mm loose.

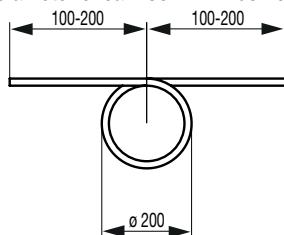

Cable PUR black
 6 x 0.25mm²
 Length: 15000mm +/- 50mm
 Wire colors: white / grey / brown / pink / green / yellow
 End: 25mm dismantled
 4mm stripped and tin coated

All Variants

Mounting Diameter [mm]	Terminal	Housing Material, Torsion Protection	Colour of Housing	Actuator area	Illumination, LED	Config. Code	Order Number
22	PUR cable	Stainless Steel ,no	-	E	RI, RGB	PSE M 22 NO RI	3-105-290
30	PUR cable	Stainless Steel ,no	-	E	RI, RGB	PSE M 30 NO RI	3-102-521

Nut with gasket are enclosed in the box.

Other mounting diameters, materials, colors, connections, supply voltages possible available on request.

Availability for all products can be searched real-time: <https://www.schurter.com/en/info-center/support-tools/stock-check-distributors>

Legend:

Type: PSE

NO = normaly open

RI = Ring Illumination

ES = Stainless steel

F = Finger guidance

E = without finger guidance

Packaging unit

1 in box with insert or packed in air cushion bags



- Actuating elements in ESD safe packaging
- Screw nuts and sealing O-ring in a bag (enclosed in the box)