

1-stage filter for 3-phase systems

new



See below:

Approvals and Compliances

Description

- Line filter as standard version
- 1 stage
- Filter with standard or high attenuation (HP)

Unique Selling Proposition

- Slim housing
- Metal base plate for optimum ground connection to the rail
- Filter variants with standard and high attenuation
- Simple snap-on mounting

Applications

- Voltage rating 520 VAC for world wide acceptance
- For 3-phase industrial applications in the control cabinet
- Machine control systems, switching power supplies, inverters
- Suitable for use in equipment according to IEC/UL 62368-1

References

Weblinks

[pdf data sheet](#), [html datasheet](#), [General Product Information](#), [Approvals](#), [Distributor-Stock-Check](#), [Detailed request for product](#), [Microsite](#)

Technical Data

Rated Current	3 - 32 A
Rated voltage	300/520 VAC, 50/60 Hz
Approval for	3 - 32 A @ 40 °C / 300/520 VAC; 50/60 Hz
Overload Current	1.5 x I _r for 1 minute, per hour
Dielectric Strength	> 2.25 kVDC between L-L 2.25 kVDC between L-PE Test voltage 2 sec
Number of Filter Stages	1-stage
Weight	0.4 kg
Material: Housing	Plastics

Mounting	DIN Rail
Terminal	Screw clamps
Operating Temperature	-40 °C to 100 °C
Climatic Category	40/100/21 acc. to IEC 60068-1
Degree of Protection	IP20 acc. to IEC 60529
Protection Class	Suitable for appliances with protection class I acc. to IEC 61140
MTBF	> 200'000h acc. to MIL-HB-217 F

Approvals and Compliances

Detailed information on product approvals, code requirements, usage instructions and detailed test conditions can be looked up in [Details about Approvals](#)

SCHURTER products are designed for use in industrial environments. They have approvals from independent testing bodies according to national and international standards. Products with specific characteristics and requirements such as required in the automotive sector according to IATF 16949, medical technology according to ISO 13485 or in the aerospace industry can be offered exclusively with customer-specific, individual agreements by SCHURTER.

Approvals

The approval mark is used by the testing authorities to certify compliance with the safety requirements placed on electronic products.

Approval Reference Type: FMAD CP

Approval Logo	Certificates	Certification Body	Description
	DEMKO Approvals	DEMKO	Certificate Number: ENEC-04869
	UL Approvals	UL	UR File Number: E495089

Product standards

Product standards that are referenced

Organization	Design	Standard	Description
	Designed according to	IEC 60939	Passive filters for suppressing electromagnetic interference
	Designed according to	UL 60939-3	Passive filters for suppressing electromagnetic interference





Application standards

Application standards where the product can be used

Organization	Design	Standard	Description
	Suitable for applications acc.	IEC/UL 62368-1	Audio/video, information and communication technology equipment - Part 1: Safety requirements

Compliances

The product complies with following Guide Lines

Identification	Details	Initiator	Description
	CE declaration of conformity	SCHURTER AG	The CE marking declares that the product complies with the applicable requirements laid down in the harmonisation of Community legislation on its affixing in accordance with EU Regulation 765/2008.
	UKCA declaration of conformity	SCHURTER AG	The UKCA marking declares that the product complies with the applicable requirements laid down in the British Amendment of Regulation (EC) 765/2008.
	RoHS	SCHURTER AG	Directive RoHS 2011/65/EU, Amendment (EU) 2015/863
	China RoHS	SCHURTER AG	The law SJ / T 11363-2006 (China RoHS) has been in force since 1 March 2007. It is similar to the EU directive RoHS.
	REACH	SCHURTER AG	On 1 June 2007, Regulation (EC) No 1907/2006 on the Registration, Evaluation, Authorization and Restriction of Chemicals 1 (abbreviated as "REACH") entered into force.

Dimension [mm]

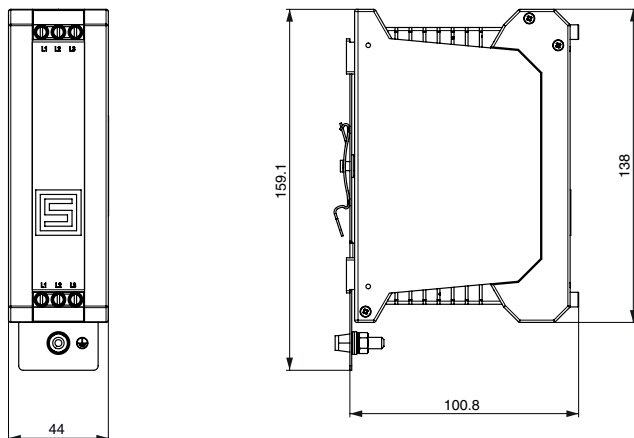

Diagrams

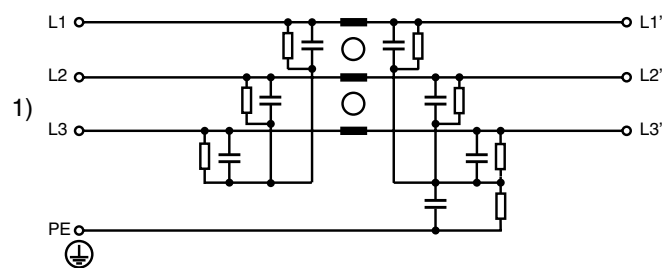

1) Line

Attenuation Loss

--- 50Ω differential mode ___ 50Ω common mode

Standard version

3 A

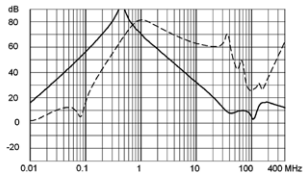

6 A

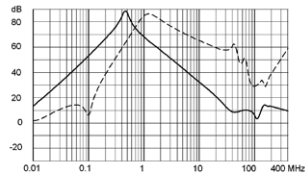

10 A

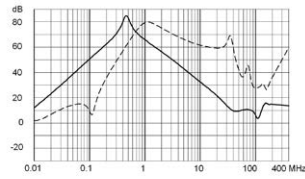

12 A

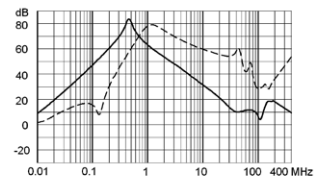

16 A

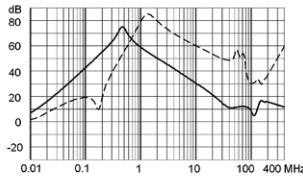

20 A

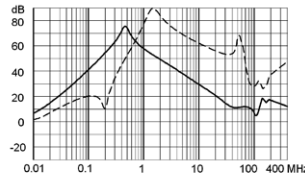

25 A

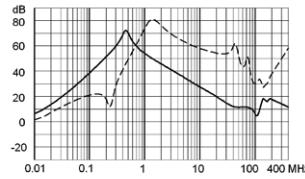

32 A

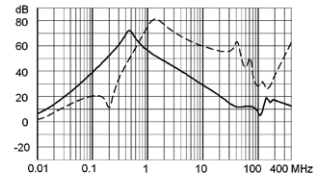

Standard HP

3 A

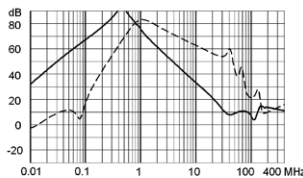

6 A

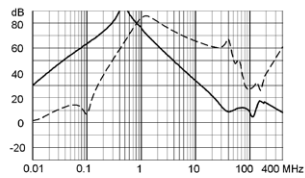

10 A

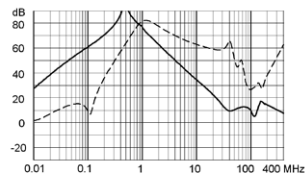

12 A

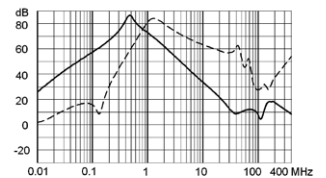

16 A

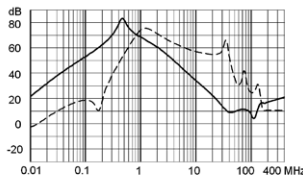

20 A

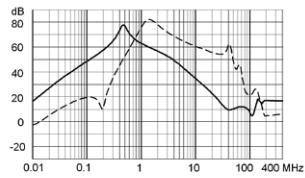

25 A

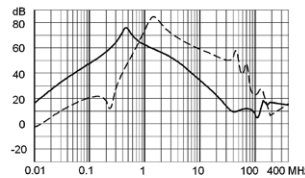

32 A

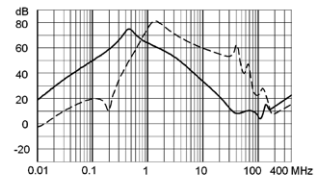

All Variants

Rated Current @ Ta 50°C [A]	Filter Type	Power Dissipation [W]	Contact Resi- stance [mΩ]	Leakage Current [mA] @ 440V, 60Hz 1)	Order Number
3	Standard version	0.29	31.7	1.31	3-150-001
6	Standard version	0.73	20.2	1.31	3-150-002
10	Standard version	1.31	13.1	1.31	3-150-003
12	Standard version	1.44	10	1.31	3-150-004
16	Standard version	1.97	7.7	1.31	3-150-005
20	Standard version	1.64	4.1	1.31	3-150-006
25	Standard version	2.5	4	1.31	3-150-007

Rated Current @ Ta 50°C [A]	Filter Type	Power Dissipation [W]	Contact Resi- stance [mΩ]	Leakage Current [mA] @ 440V, 60Hz 1)	Order Number
32	Standard version	3.79	3.7	1.31	3-150-008
3	Standard version HP	0.29	32.3	1.31	3-150-011
6	Standard version HP	0.74	20.6	1.31	3-150-012
10	Standard version HP	1.39	13.9	1.31	3-150-013
12	Standard version HP	1.43	9.9	1.31	3-150-014
16	Standard version HP	1.97	7.7	1.31	3-150-015
20	Standard version HP	1.8	4.5	1.31	3-150-016
25	Standard version HP	2.56	4.1	1.31	3-150-017
32	Standard version HP	3.89	3.7	1.31	3-150-018

Availability for all products can be searched real-time: <https://www.schurter.com/en/info-center/support-tools/stock-check-distributors>

1) Leakage current according IEC 60939-1

Packaging unit

6 Pcs