

IEC Appliance Inlet C14/C18, Snap-in Mounting, Front Side, Solder or Quick-connect or Screw-on Terminal

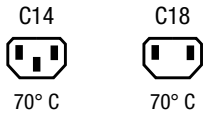

See below:  
[Approvals and Compliances](#)

**Description**

- Panel mount :  
 Snap-in version , Front Side
- 1 Function :
- Appliance Inlet , Pin temperature 70 °C , protection class I or II
- Solder / Quick Connect / Screw Terminals

**References**

**Weblinks**  
[pdf data sheet](#), [html datasheet](#), [General Product Information](#), [Approvals](#),  
[Distributor-Stock-Check](#), [Accessories](#), [Detailed request for product](#)

**Technical Data**

Ratings IEC	10A / 250VAC; 50/60Hz	Appliance inlet/-outlet	C14 / C18 acc. to IEC 60320-1
Ratings UL/CSA	15A / 250VAC; 60Hz		UL 60320-1, CSA C22.2 no. 60320-1
Dielectric Strength	> 2.5kVAC between L-N		(for cold conditions) pin-temperature 70 °C, 10A, Protection Class I or II
	> 1.5kVAC between L/N-PE (1 min/50Hz)		
Allowable Operation Temperature	-25 °C to 70 °C		
IP-Protection	front side IP20 acc. to IEC 60529		
Protection against electric shock	Suitable for appliances with protection class I or II acc. to IEC 61140		
Terminal	Solder / Quick Connect / Screw Terminals		
Panel Thickness S	Snap-in version		
	0.8 - 1.5/1.6 - 2.0 mm		
Material: Housing	PA6, black or grey, UL 94V-0		

**Approvals and Compliances**

Detailed information on product approvals, code requirements, usage instructions and detailed test conditions can be looked up in [Details about Approvals](#)

SCHURTER products are designed for use in industrial environments. They have approvals from independent testing bodies according to national and international standards. Products with specific characteristics and requirements such as required in the automotive sector according to IATF 16949, medical technology according to ISO 13485 or in the aerospace industry can be offered exclusively with customer-specific, individual agreements by SCHURTER.

**Approvals**

The approval mark is used by the testing authorities to certify compliance with the safety requirements placed on electronic products.  
 Approval Reference Type: 1061

Approval Logo	Certificates	Certification Body	Description
	<a href="#">VDE Approvals</a>	VDE	Certificate Number: 40011871
	<a href="#">UL Approvals</a>	UL	UR File Number: E96454
	<a href="#">CCC Approvals</a>	CCC	CCC Certificate Number: 2019180204011843

## Product standards

Product standards that are referenced

Organization	Design	Standard	Description
	Designed according to	IEC 60320-1	Appliance couplers for household and similar general purposes
	Designed according to	UL 60320-1	Standard for Attachment Plugs and Receptacles
	Designed according to	CSA C22.2 no. 60320-1	General Use Receptacles, Attachment Plugs, and Similar Wiring Devices





## Application standards

Application standards where the product can be used

Organization	Design	Standard	Description
	Suitable for applications acc.	IEC/UL 62368-1	Audio/video, information and communication technology equipment - Part 1: Safety requirements

## Compliances

The product complies with following Guide Lines

Identification	Details	Initiator	Description
	<a href="#">CE declaration of conformity</a>	SCHURTER AG	The CE marking declares that the product complies with the applicable requirements laid down in the harmonisation of Community legislation on its affixing in accordance with EU Regulation 765/2008.
	<a href="#">UKCA declaration of conformity</a>	SCHURTER AG	The UKCA marking declares that the product complies with the applicable requirements laid down in the British Amendment of Regulation (EC) 765/2008.
	RoHS	SCHURTER AG	Directive RoHS 2011/65/EU, Amendment (EU) 2015/863
	China RoHS	SCHURTER AG	The law SJ / T 11363-2006 (China RoHS) has been in force since 1 March 2007. It is similar to the EU directive RoHS.
	REACH	SCHURTER AG	On 1 June 2007, Regulation (EC) No 1907/2006 on the Registration, Evaluation, Authorization and Restriction of Chemicals 1 (abbreviated as "REACH") entered into force.

## Dimensions [mm]

Quick connect or solder terminals

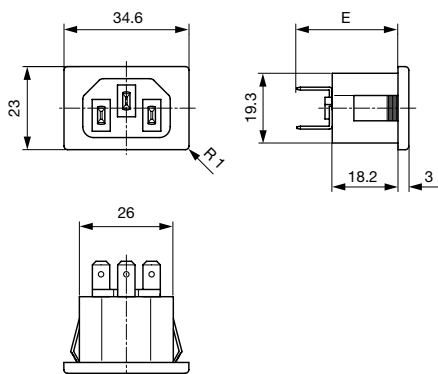

Wandstärke panel thickness	Ausbruchmasse panel cutout
0.8 - 1.5 mm	28.8 <sup>+0.2</sup> x 19.4 <sup>+0.2</sup> mm
1.6 - 2.0 mm	29.6 <sup>+0.2</sup> x 19.4 <sup>+0.2</sup> mm

E: Solder terminals short: 23.7 mm

E: Solder terminals long: 27.1 mm

E: Quick connect terminals 4.8x0.8 mm: 27.9 mm

E: Quick connect terminals 6.3x0.8 mm: 28.9 mm

Bolts and nuts

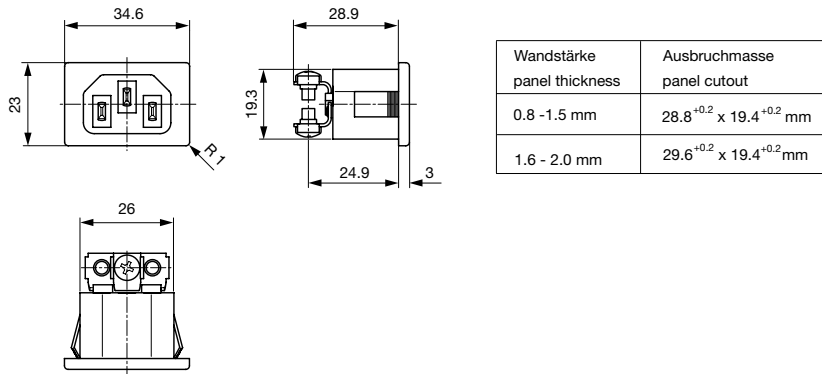

Config. Code





1061 - H - A B C 0 - D - E O

The characters are placeholders for the correspondingly keys of selections from the key tables.

1061 - H - A B C 0 - D - E O = Type

Type	Configuration key
protection class II	B
protection class I	X

1061 - H - A B C 0 - D - E O = Terminals

Terminal L	Configuration key
Solder terminal (L = 5.0mm) large soldering hole 	1
short solder terminal (L = 4.8 mm) 	2
long solder terminal (L = 8.5 mm) 	3
Blade terminal (4.8 x 0.8 mm) 	8
Blade terminal (6.3 x 0.8 mm) 	9
screw terminal	A

1061 - H - A B C 0 - D - E O = Terminals

Terminal N	Configuration key
Solder terminal (L = 5.0mm) large soldering hole	1
short solder terminal (L = 4.8 mm)	2
long solder terminal (L = 8.5 mm)	3
Blade terminal (4.8 x 0.8 mm)	8
Blade terminal (6.3 x 0.8 mm)	9

Symbols similar as in table A

Terminal N	Configuration key
screw terminal	A
Symbols similar as in table A	

1061 - H - A B C 0 - D - E O = Terminals

Terminal Ground	Configuration key
without terminal	0
Solder terminal (L = 5.0mm) large soldering hole	1
short solder terminal (L = 4.8 mm)	2
long solder terminal (L = 8.5 mm)	3
Blade terminal (4.8 x 0.8 mm)	8
Blade terminal (6.3 x 0.8 mm)	9
screw terminal	A
Symbols similar as in table A	

1061 - H - A B C 0 - D - E O = Color

Color	Configuration key
Black	A
Grey	B

1061 - H - A B C 0 - D - E O = Style

Style	Configuration key
snap-in standard type	3

1061 - H - A B C 0 - D - E O = Features

Features	Configuration key
without V-Lock	0
V-Lock	V

Mating Outlets/Connectors shuttered



[Power Cord Overview complete](#)

VAC17KS, V-Lock cord retaining, diverse m, Connector IEC C17, diverse, black / grey / white	VAC17KS
---	---------

[Interconnection Cord Overview complete](#)



Cord Sets 10 A, Interconnection, 2.0 m, IEC H05VV-F3G1.0, black	6007.0204
Cord Sets 10 A, Interconnection, 1.0 m, Connector IEC C13, H05VV-F3G1.0, black	6007.0212
Cord Sets 10 A, Interconnection, 2.0 m, Connector IEC C13, H05VV-F3G1.0, black	6007.0214

[Power Supply Cord Overview complete](#)



Cord Sets 10 A, Europlug, 2.5 m, Connector IEC C13, H05VV-F3G1.0, black	6004.0215
Cord Sets 10 A, Europlug, 2.5 m, Connector IEC C13, H05VV-F3G1.0, black	6003.0215
Cord Sets 10 A, uninsulated wires, 2.0 m, Connector IEC C13, H05VV-F3G1.0, black	6000.0224
Cord Sets 10 A, uninsulated wires, 2.0 m, Connector IEC C13, H05VV-F3G1.0, black	6000.0214
Cord Sets 10 A, United Kingdom, 2.5 m, Connector IEC C13, H05VV-F3G1.0, black	6044.0215

...

[Power Supply or Interconnection Cord Overview complete](#)



Cord Sets 10 A, United Kingdom, 2.0 m, Connector IEC H05VV-F3G1.0, black	6044.0204
--	-----------