

NEMA line Outlet 1-15R, Snap-in Mounting, Front Side, Solder Terminal



Snap-in version



See below:

[Approvals and Compliances](#)

Description

- Panel mount :
Snap-in , Front Side
- 1 Function :
Line Outlet , Protection class II
- Solder

Characteristics

- Designed for standard applications

References

Alternative: Version in protection class I [0709](#); [0709](#)

Weblinks

[pdf data sheet](#), [html datasheet](#), [General Product Information](#), [Approvals](#), [Distributor-Stock-Check](#), [Accessories](#), [Detailed request for product](#)

Technical Data

Ratings UL/CSA	15A / 125VAC; 60Hz
Allowable Operation Temperature	-40 °C to 60 °C
IP-Protection	front side IP20 acc. to IEC 60529
Protection against electric shock	Suitable for appliances with protection class II acc. to IEC 61140
Terminal	Solder terminals
Panel Thickness S	Snap-in 0.8mm to 1.5mm
Material: Housing	Thermoplastic, black

Approvals and Compliances

Detailed information on product approvals, code requirements, usage instructions and detailed test conditions can be looked up in [Details about Approvals](#)

SCHURTER products are designed for use in industrial environments. They have approvals from independent testing bodies according to national and international standards. Products with specific characteristics and requirements such as required in the automotive sector according to IATF 16949, medical technology according to ISO 13485 or in the aerospace industry can be offered exclusively with customer-specific, individual agreements by SCHURTER.

Approvals





The approval mark is used by the testing authorities to certify compliance with the safety requirements placed on electronic products.

Approval Reference Type: 0715

Approval Logo	Certificates	Certification Body	Description
	UL Approvals	UL	UR File Number: E103791
	CSA Approvals	CSA	CSA Certification Record: 73165

Product standards

Product standards that are referenced

Organization	Design	Standard	Description
	Designed according to	IEC 60320-1	Appliance couplers for household and similar general purposes
	Designed according to	IEC 60320-1	Appliance couplers for household and similar general purposes
	Designed according to	UL 498	Standard for Attachment Plugs and Receptacles
	Designed according to	CSA C22.2 no. 42	General Use Receptacles, Attachment Plugs, and Similar Wiring Devices





Application standards

Application standards where the product can be used

Organization	Design	Standard	Description
	Designed for applications acc.	IEC/UL 62368-1	Audio/video, information and communication technology equipment - Part 1: Safety requirements

Compliances

The product complies with following Guide Lines

Identification	Details	Initiator	Description
	CE declaration of conformity	SCHURTER AG	The CE marking declares that the product complies with the applicable requirements laid down in the harmonisation of Community legislation on its affixing in accordance with EU Regulation 765/2008.
	UKCA declaration of conformity	SCHURTER AG	The UKCA marking declares that the product complies with the applicable requirements laid down in the British Amendment of Regulation (EC) 765/2008.
	China RoHS	SCHURTER AG	The law SJ / T 11363-2006 (China RoHS) has been in force since 1 March 2007. It is similar to the EU directive RoHS.
	REACH	SCHURTER AG	On 1 June 2007, Regulation (EC) No 1907/2006 on the Registration, Evaluation, Authorization and Restriction of Chemicals 1 (abbreviated as "REACH") entered into force.

Dimensions [mm]

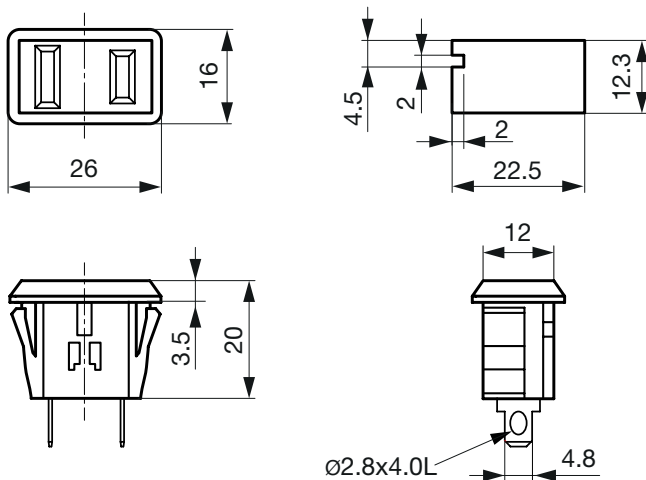

All Variants

Alignment 1)	Protection Class	Panel mounting	Panel Thickness s [mm]	Terminal	Color	Order Number
along	II	Snap-in	0.8 to 1.5	Solder	black	4300.0705

1) The alignment describes whether the wires are along or across to the connector pin axis.

Availability for all products can be searched real-time: <https://www.schurter.com/en/Stock-Check/Stock-Check-SCHURTER>

Packaging unit 200 Pcs

Mating Inlets/Plugs

Category / Description



[Power Supply Cord Overview complete](#)

Cord Set 2.5A, North America, Black, 2.5 SVT 2x18AWG, IEC C7, SVT 2x18 AWG, black

6051.0018
